

INSIDE CORNER (PLAN VIEW)
FLASHING INSTALLED BEFORE WRB

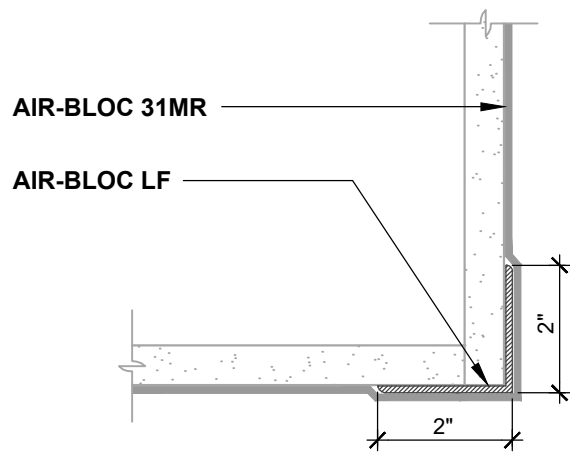

OUTSIDE CORNER (PLAN VIEW)
FLASHING INSTALLED BEFORE WRB

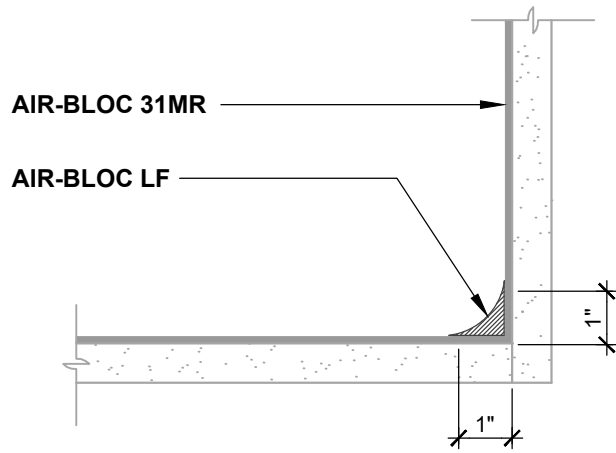

INSIDE CORNER (PLAN VIEW)
FLASHING INSTALLED AFTER WRB

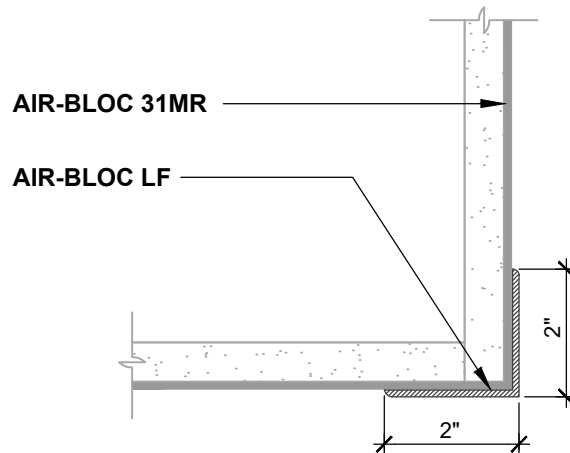

OUTSIDE CORNER (PLAN VIEW)
FLASHING INSTALLED AFTER WRB

NOTES:

1. DETAIL SHOWS **AIR-BLOC 31MR FLUID APPLIED VAPOR PERMEABLE AIR BARRIER**. SUBSTRATE SHOWN IS FOR REFERENCE ONLY. ACCEPTABLE SUBSTRATES FOR **AIR-BLOC LF** CORNER FLASHING INCLUDE EXTERIOR GRADE SHEATHING.
2. OSB AND PLYWOOD SUBSTRATES REQUIRE A SELF-ADHERED FLASHING AT INSIDE/OUTSIDE CORNERS. REFER TO DETAIL AB31MR-3A-1.
3. PRIME CUT/RAW EDGES OF EXPOSED GYPSUM SHEATHING CORE PRIOR TO **AIR-BLOC LF** APPLICATION. RECOMMENDED PRIMER/ADHESIVE INCLUDE: **BLUESKIN SPRAY PREP**.
4. INSTALL **AIR-BLOC 31MR** TO ACHIEVE A CONTINUOUS WATER-RESISTIVE BARRIER (WRB). INSULATION, CLADDING AND OPTIONAL VAPOR BARRIER NOT SHOWN FOR CLARITY. REFER TO LOCAL CODE ORDINANCES FOR INSULATION AND VAPOR BARRIER REQUIREMENTS.
5. REFER TO PRODUCT SPECIFIC TECHNICAL DATA SHEET (TDS) AND **AIR-BLOC 31MR** GUIDE SPECIFICATION FOR INSTALLATION PROCEDURES.

Henry[®]

999 N. Pacific Coast Highway, Suite 800
El Segundo, CA 90245
800-486-1278 • www.henry.com

MANUFACTURER GUIDE DETAILS ARE FOR REFERENCE ONLY. HENRY DOES NOT ASSUME RESPONSIBILITY FOR ERRORS OR DEVIATIONS IN DESIGN OR ENGINEERING. PROJECT SPECIFIC VERIFICATION IS RECOMMENDED PRIOR TO INSTALLATION.

AIR-BLOC 31MR FLUID APPLIED VAPOR PERMEABLE AIR BARRIER

INSIDE/OUTSIDE CORNERS

**EXTERIOR GRADE SHEATHING
LIQUID APPLIED FLASHING**

SCALE: N.T.S.

03-05-2020

AB31MR-3A-2